

Operation Manual



Safety notice

1. The electrical installation should be performed by a qualified technician or professional.
2. The power supply should match the electric parameter of the product, certified GFCI Circuit . distance among outlets \cong 3mm.
3. Cutting any wire on this product is strictly prohibited in the process of handling installation. Do not take apart computer control box, control panel or remote control, or warranty will be void.
4. Before using, check whether power is sufficient? Whether control faucet is open.
5. Avoid Organic liquid like Acetone, ammonia, petrol and vitriol chemicals that will blemish the acrylic surface and plated parts.

Advice:

1. Pay attention to high temperatures to prevent burns when using the steam shower.
2. Persons that are intoxicated, hypertensive, asthmatic, or have heart disease should avoid prolonged use of the steam shower.
3. Children should be accompanied with adult when using the steam shower.
4. close the door and do not enter the steam shower when the sterilization is on.
5. The massage bath tub can not be filled while using the steam shower.
6. Don't forget to cut water supply and power supply after each use.
7. Unit must be properly grounded.
8. Out door use is not allowed.

Warning:

Users must operate according to the Safety Notice and installation requirements otherwise, personal injury may occur

The manufacturer reserves the right to modify this unit and technical parameters at any time .

Technical parameter

Product Features - Standard Configuration

Function and device		
MODEL	Foot massage	●
	Bubble	●
	Steam cleaning function	●
	Water Inlet (Tub)	●
	Waterfall Inlet	
	Under-water lamp	●
	Surf	●
	Manual drainer	●
	Drainer	●
	Steam Generator protection	●
	Top light	●
	Sliding handle shower	●
	Top shower	●
	Time setting	●
	Temperature setting	●
	Temperature detector	●
	Acupuncture massage	●
Multi-function shower	●	
Hydraulic pressure adjustor	●	
Cold / Hot Water Switch	●	
Telephone answer	●	
Bluetooth	●	
FM Radio	●	
Steam bath	●	
Ozone sterilization	●	
Exhaust Fans	●	
Control Panel	●	

Electric Parameter:

Model	Size(mm)	Electrical source voltage (V)	Rated Power (Hz)	Rated current (A)	Steam generator (W)	Pump (W)	Blower (W)
	1790X960X2230			≈ 30	5000	750	300

The information of this table are only reference, the company have right to amend the technique parameter、 specification 、 model、 collocate before any advance inform, the detail please inquire about dealer.

Water Parameter:

Work hydraulic pressure	Current capacity	Diameter of drainer	
Mpa	L/min	Cold/hot water	Drainer
0.2-0.4	8-12	DN15	DN40

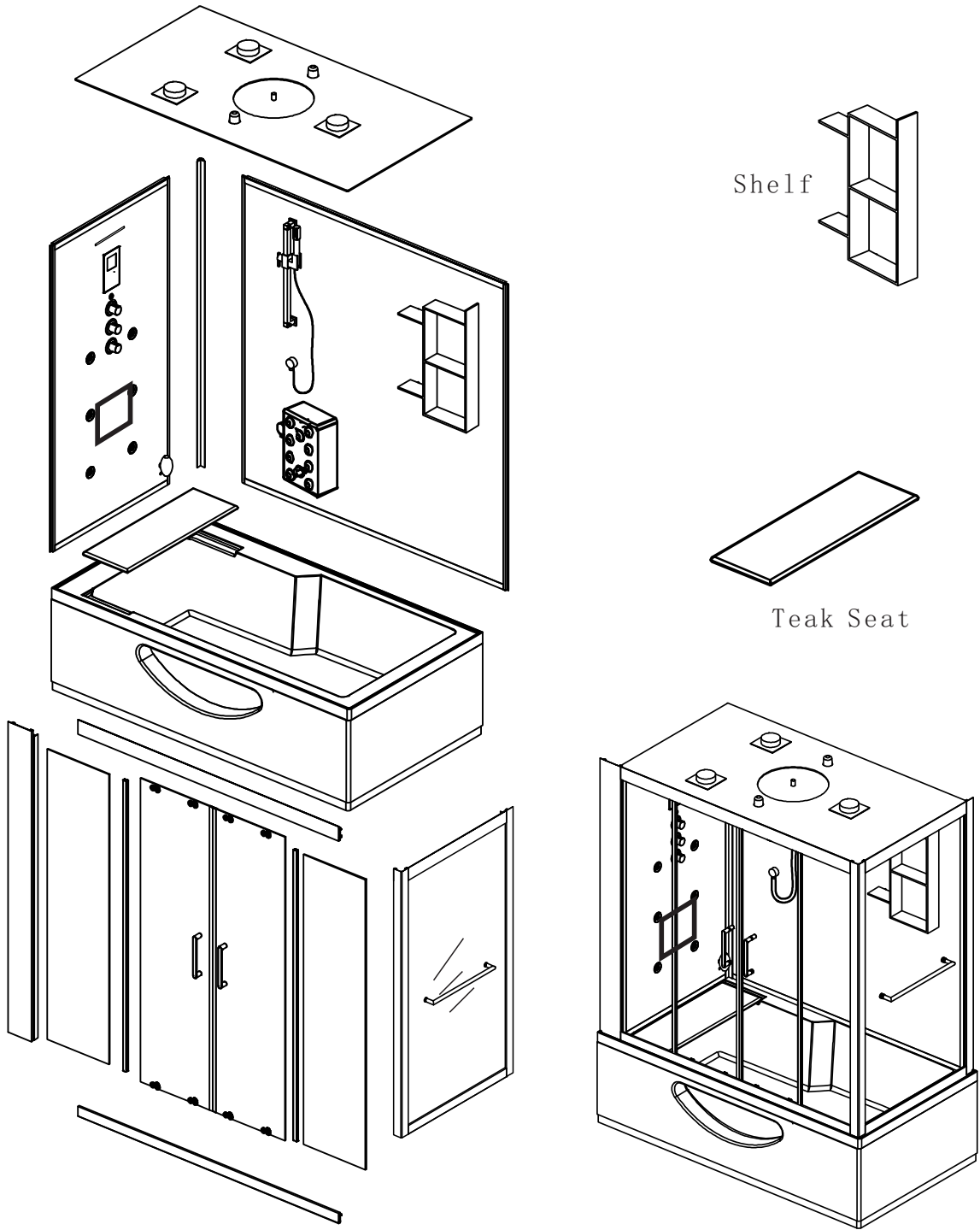

SIZE: 1790X960X2230

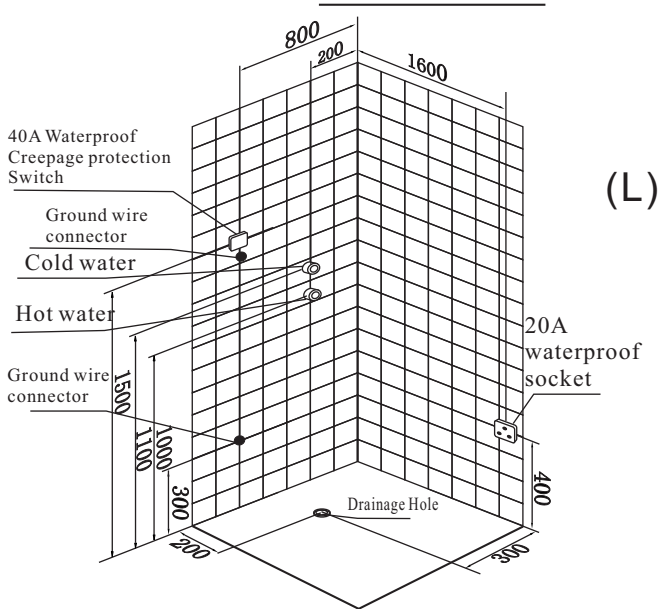

(L)

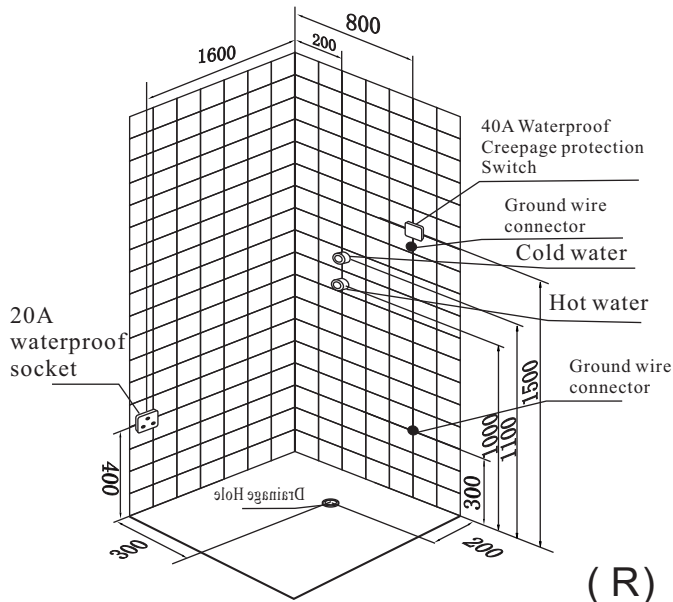
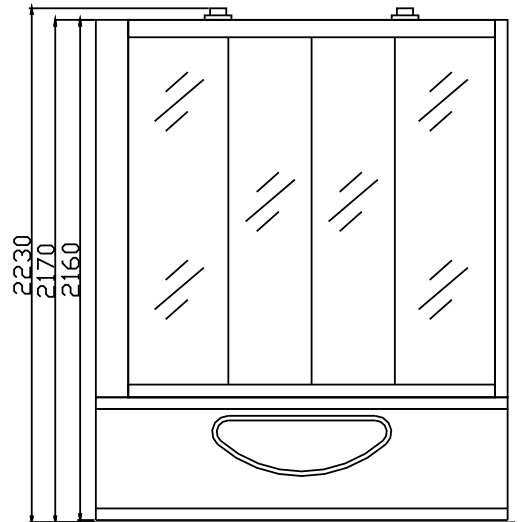

(R)

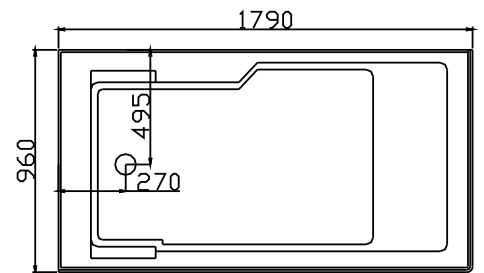

Plane Dimension Drawing

Three-dimensional Installation Dimension Drawing

1. Water Supply: One Cold and one Hot pipe. Shut-off Valve with outside Yoke (DN15(G1/2)) shall be mounted on the wall which should be 1000mm above from the ground. $0.15\text{mPa} = \text{Pressure} = 0.4\text{mPa}$.
2. The steamer power: 5000W. Power supply voltage: AC240V \pm 10%. Frequency: 60Hz. Single Phase and Three Wire System with 3X6mm² rubber-insulated copper wire which is independent loop. The steamer is mounted with the Creepage Overload Protection device and must have the reliable ground wire. Bathtub body: 6050W/AC220V/60Hz. Single Phase and Three Wire System. BV=3x6mm². With one 40A Water Proof Socket. This product must be powered through Electric Creepage protection plug and Overload Protection Device with less than 30mA electric current. The ground wire of appliance must be permanently connected to valid and reliable ground wire of Power Supply.
3. Water Drainage: The floor drainage hole should be the same or bigger than DN50, and should be on a line with the ground.

LIST

			
M4*10 (25PCS)	M4*6 (5PCS)	M4*25 (8PCS)	M4*25 (2PCS)
			
Spare (used to the water pipe)	Spare (used to fixing the tray and glass)	Spare (used to the pipe which being connect the jets)	Spare (the screws are used to the technical)
			
"U"seal	"F"seal	single side seal	connector for aluminum M4*10 (4PCS)
			
H3 seal	H4 seal		

Operation Instruction Of Steam Room

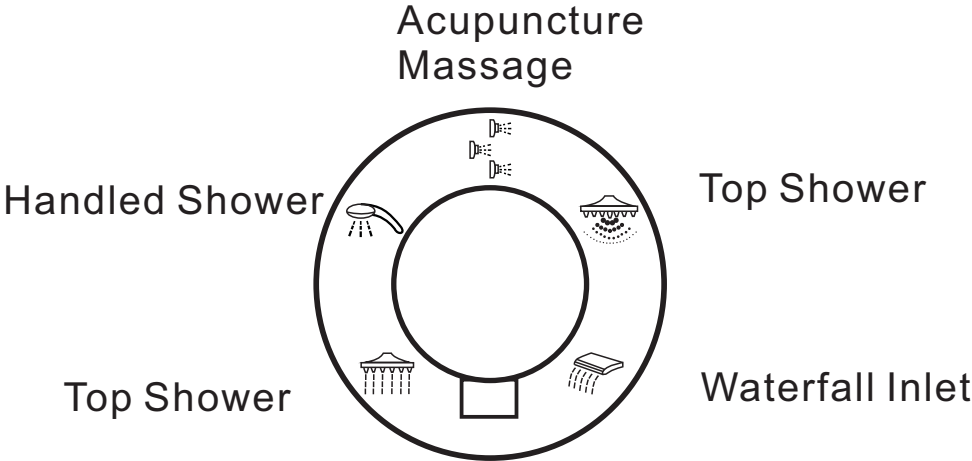

Turn valve to the desired function

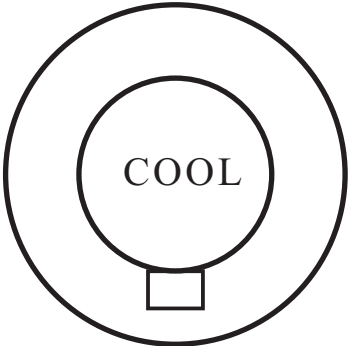
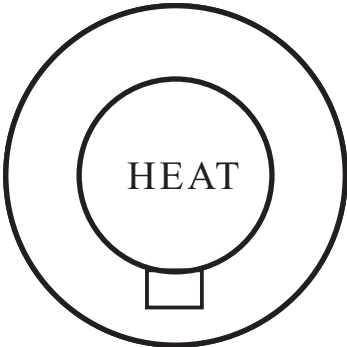

Shower sliding bar is used to support the handheld shower, press the button to adjust the height of the handheld shower



Shower Sliding Bar

manual for cleaning:
open the cap of cleaning outlet, and then put some cleaning solution, start the steam function after 5 mins.
(attention, don't touch the outlet when it is working, dangerous ! !)



Cleaning outlet



Manual Drainer

Rotate the manual drain knob to fill or drain the tub.

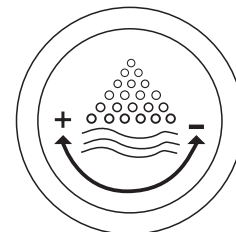
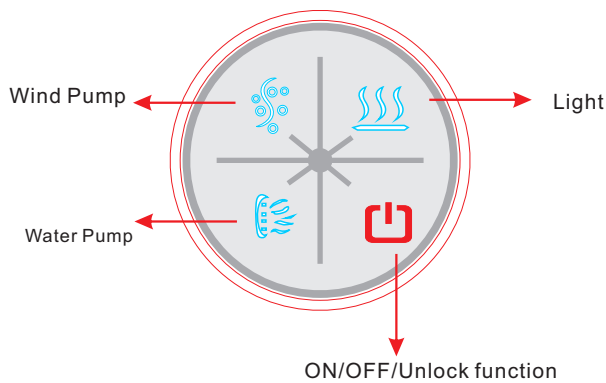

water pressure

When using the massage tub, the water level of bathtub needs to be higher than the water jet, otherwise the jet will spray water all over.

Do not turn on the water pump unless there is water in the tub. Damage can occur.

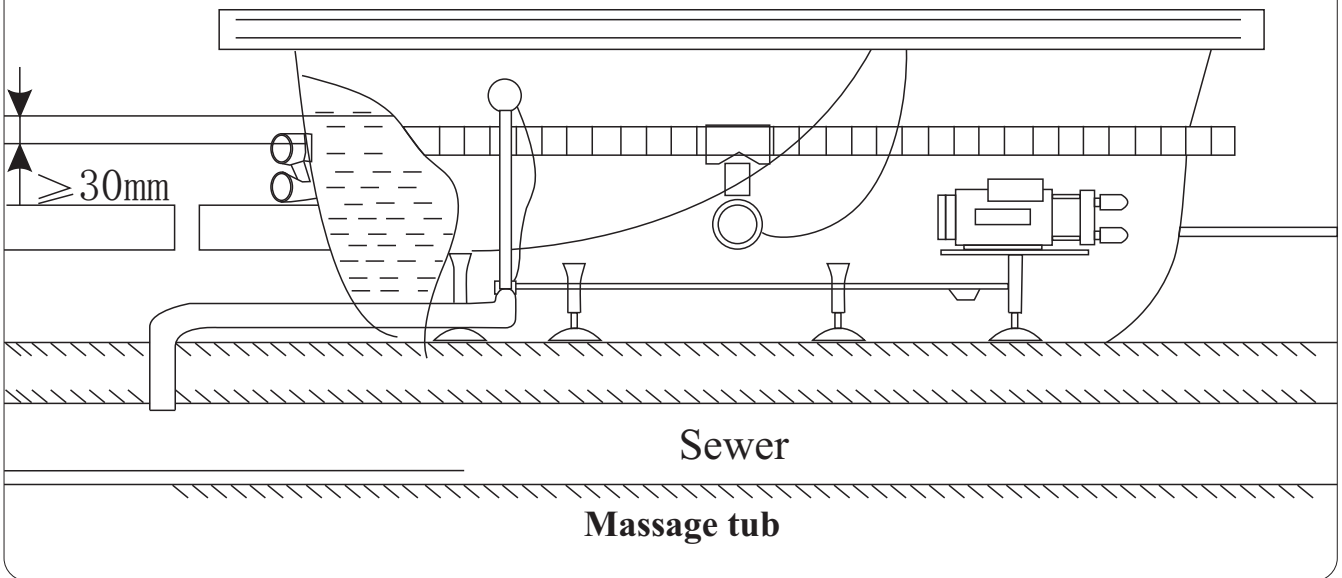

Installation steps

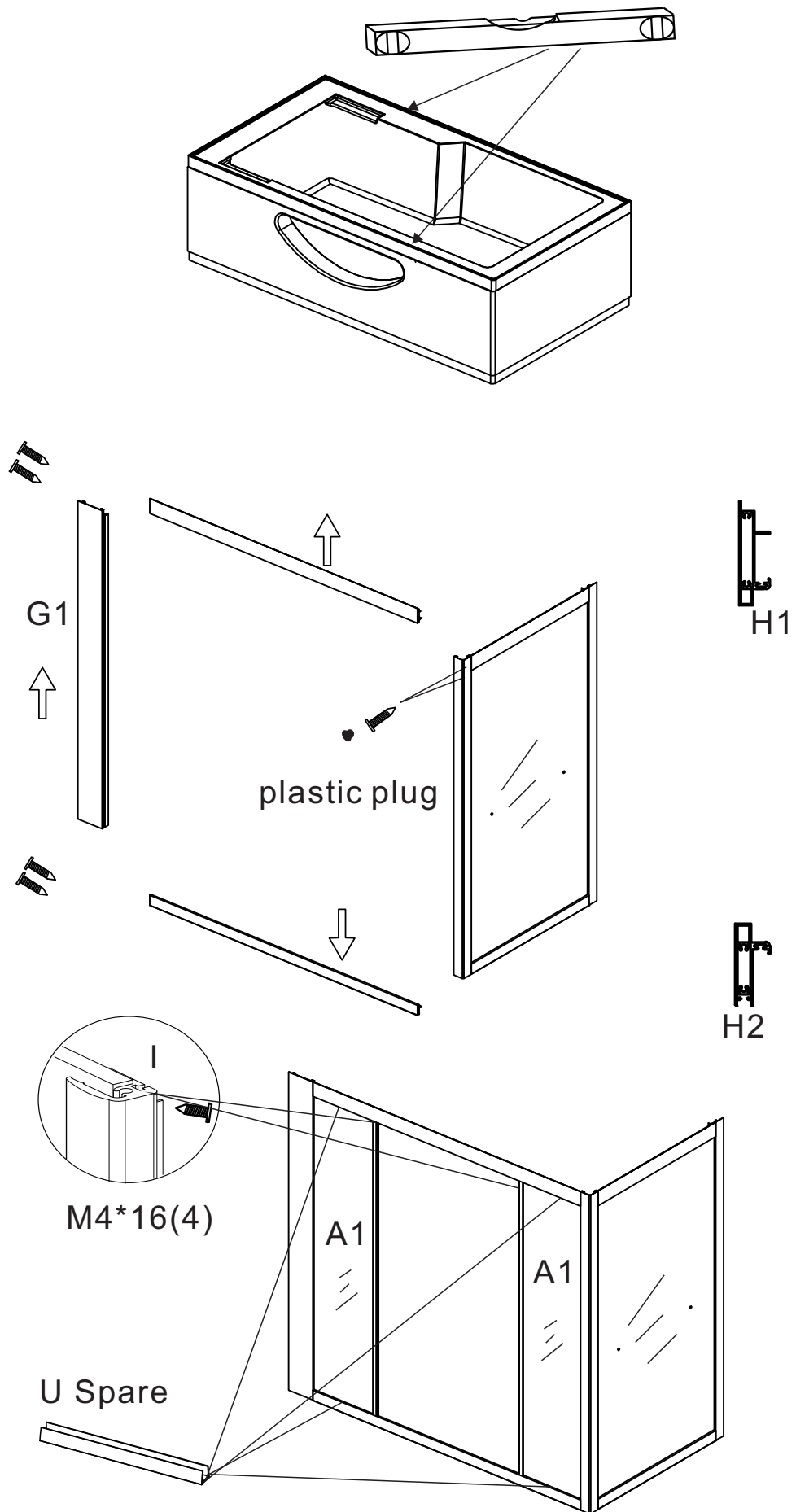

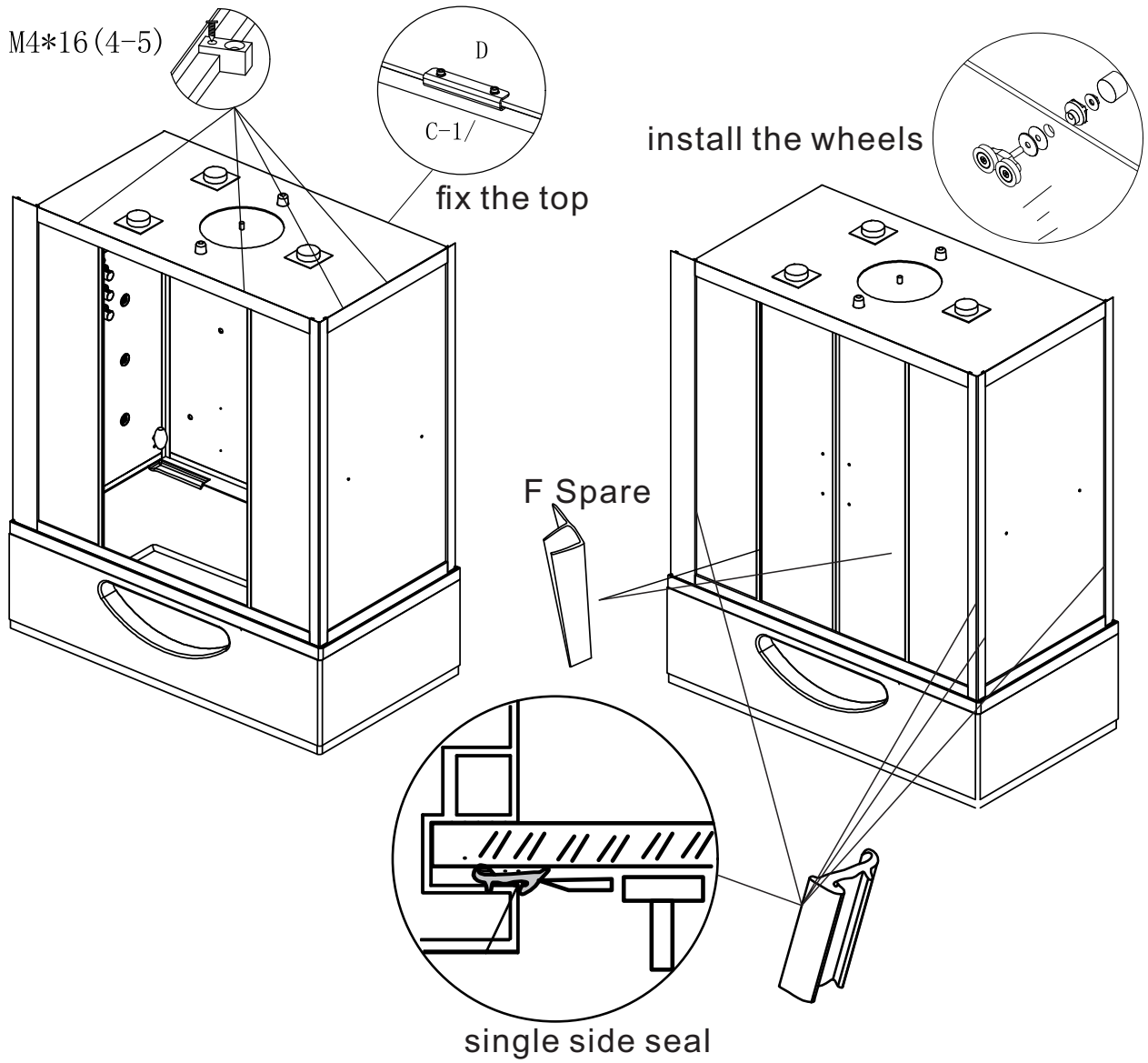
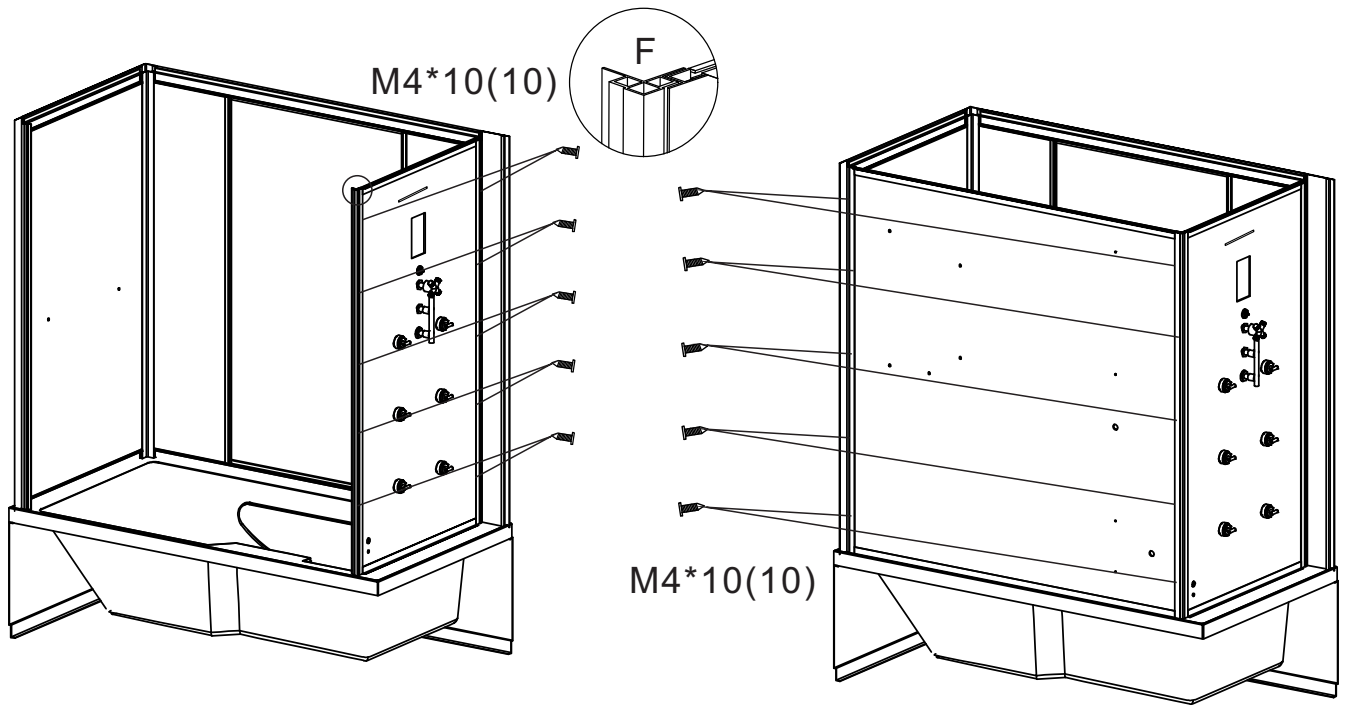

* Make some silicone to prevent leaking under the high water pressure .

Install accessory: install seat, steam box, sliding bar, shower fitting, storage shelf, towel pole, foot massage, handle etc.

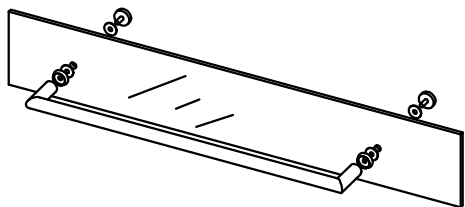

install the towel bar

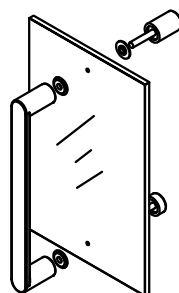

install the handle

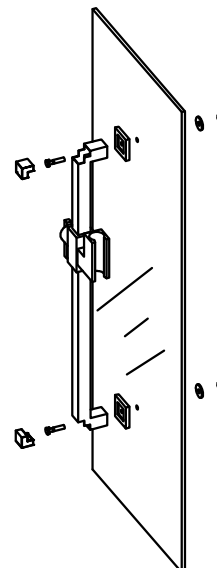

install the lift bar

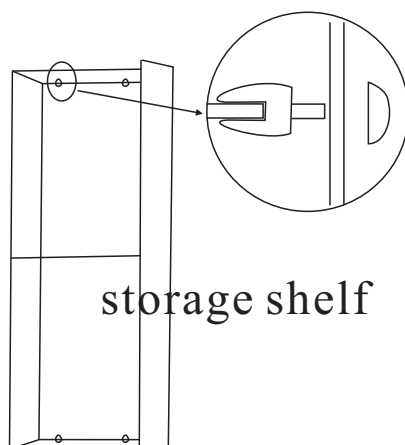

storage shelf

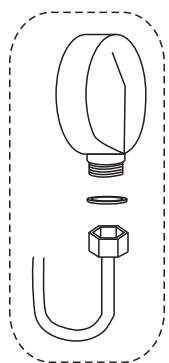

shower fitting

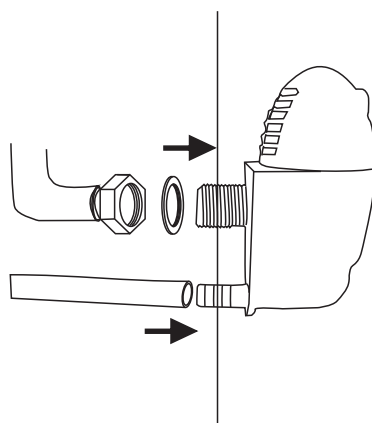

steam box

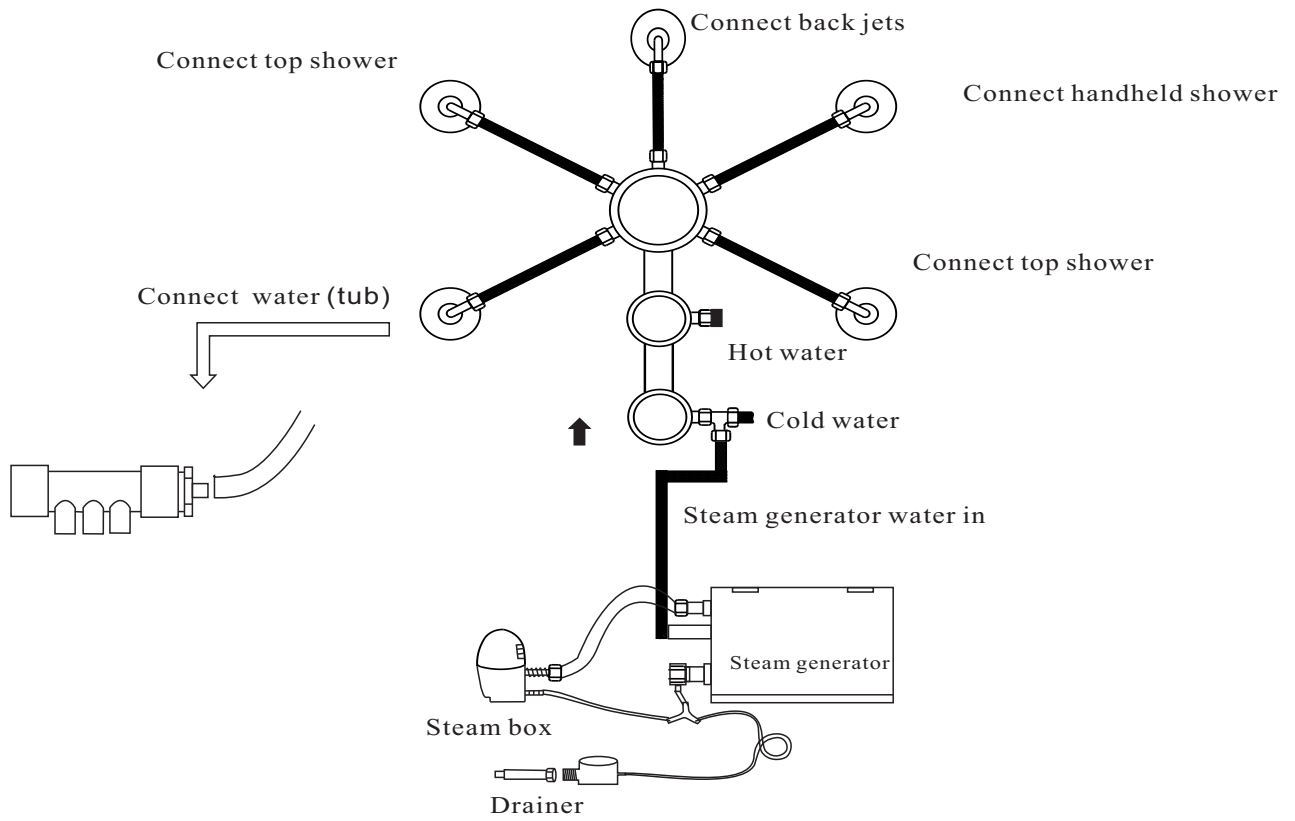

Hose diagram

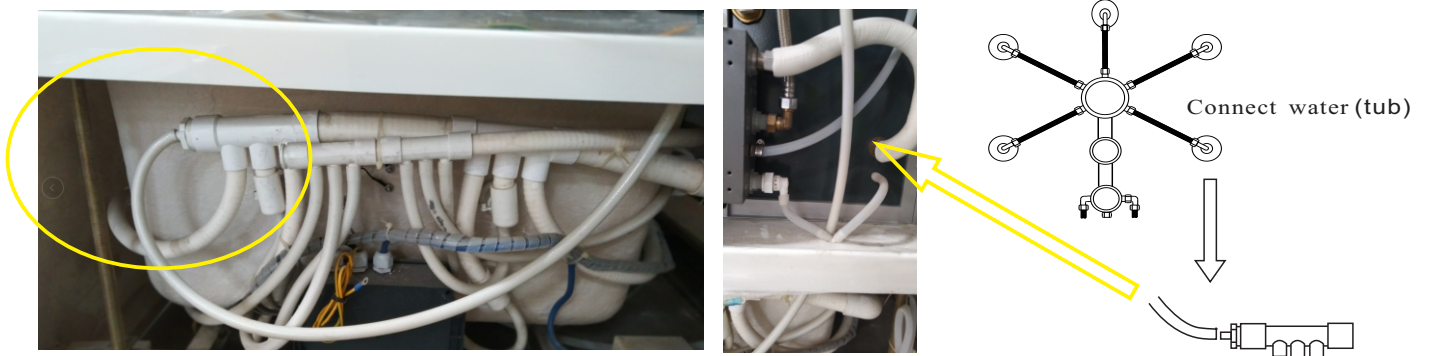

Instruction Manual of GD-9016 Model Controller



1.The Characteristics of product:

- ★ With high class micro computer controlling and anti jamming circuit, it has highly dependability.
- ★ Use the top grade induction button and dynamic LED display
- ★ The fidelity Hi-Fi FM.USB connector.MP3 function.
AUX Input Interface
- ★ Mobile phone bluetooth call. Mobliephone bluetooth music player.
- ★ The layout design is in reason ,material choosing is strict .It take apart the strong electricity and weak electricity .The room use 12V safe voltage ,customer can rest assured to use it.
- ★ phone alarm or site alarm function.

2. Parameter of technique:





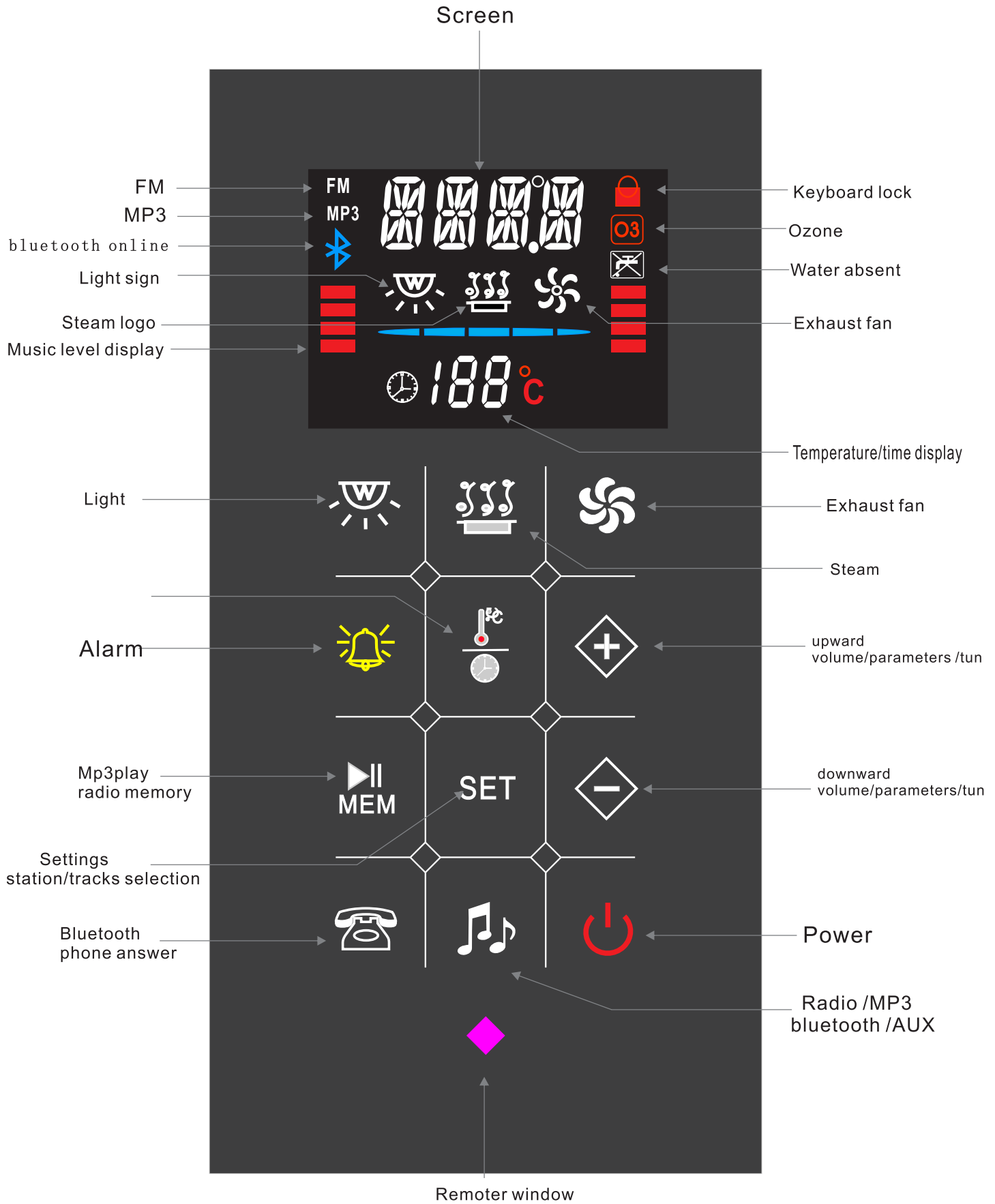

- 1、 The voltage of electrical source : AC 190V-240V,50Hz
- 2、 steam power : 3kw
- 3、 Intensity of voltage resist:1500V/min
- 4、 The creepage electricity<0.25mA
- 5、 The load of lighting:DC12V 10W
- 6、 The load of fan:DC12V 5W
- 7、 The load of music:15W
- 8、 the frequency of range:FM88-108Mhz
- 9、 USB interface music infomat: Mp3 format
- 10、 Resistance connecting the ground $\leq 0.1 \Omega$

3.Panel Features:



4. Instruction

1. Sauna Section :

- (1) Plug into the creepage switch , press the button “” , the steam system electrify, the display show the temperature in the room 。 the machine runs to base on your demand
- (2) temperature set: press  , display TEMP ,press "  "or"  " to pre-set temperature, set from 35-60°C , normal atmospheric temperature is 0-70°C ,
- (3) time set : press  ,display TIME, press "  "or"  "can pre-set temperature, set form 1-99minutes,it started to countdown when the function turn on,the function turn off automatic when countdown to the end.



Note: infrared steam function countdown leave 3 min,buzzer will "do do"deep 5 times, prompt toward the end of heating.



- (4) Fan function: press "  "to start or stop this function. .

- (5) Colorful lights:





On when the machine is on .press--to control main lamp or backlight on and off.

Main lamp on--->main lamp off(back light on)--->main lamp on(back light on)--->all off.

- (6) Infrared Steam function----Press "  " ,steam sign "  "on,steam export one min after. at this time the machine run to base on the temperature and time you set. (The tolerant temperature and time is 50C and 60 minutes) , when reach the temperature you set, the temperature is unchanged; when reaching the time you set, the steam machine is off. Steam sign off.

- (7) keyboard locking: enter to keyboard locking state and show "  "if don't operating any function key more than 2 minutes, press “” to unlock.

2、Radio section :

- (1) Pull out the radio antenna and place in -Y -form. When () key is pressed ,the screen will appear radio frequency and the volume will rise with slight sound for loudspeaker.
- (2) Search: press the key (**SET**) in menu settings,select "TUN ".press() or () key for upward or downward station select.Short press is manual station selection .Press more than 2 seconds frequency will move upward or downward automatically until the broadcasting station is received. In the case of poor receiving,environment or weak signal for receiving, it is recommended to select in manual selection mode.
- (3) Memory: After selecting the play station , press () key to display "CH-01 " , then it can be stored the station in number 1. It stored the station number will increment automatically.The station stored range is CH01 to Ch30.
- (4) repeated hearing: press the () key for selection of the position of desired station, the screen will display the number "Ch01---Ch 30 " thus you can hear the voice.

(5)AUTO Channel:

Press **SET** in to menu,select "AUTO" ,press "  "then be in auto channel selection model,then system will search channels (87.5-108mhz),lcd will show the frequency you are Sear ching.when Search channels,lcd shows--01ch,means system search the first channels,also memory it .then system will search channels by automatically till 30channels or all frequency. (The number of raido depending on local radio coverage.The system can save 30 channels.)When auto search finish, the system return to the first radio and listen normally.

- (6)Adjust the volume:Directly press  or  to adjust the volume. The screen show the volume seriesCorrespondingly.

- (7)、 Enter aux function : Connect the Exterior audio wire with the external faucet of the main control box, press () key to the position of aux ,then choose the suitable volume .

(8) USB MP3 player:

press “ 🎵 ” key to the position of Mp3 , display show **MP3** ”

MP3function is ready, insert USB disk with Mp3 music to USB connector, system search and play the tracks auto ,as the following picture.:



play/pause: press (▶||) to play or pause.

tracks select: press (**SET**) → (▲) upward track or (▼) downward track.

(9) connect with phone Bluetooth:

Press 🎵 key to the position of bluetooth, display show "BT" ,then system search bluetooth auto ,it have to bluetooth pairing at the first time to pairing , operating as follow:

open bluetooth setting of phone → open bluetooth → search equipment
→ pairing → pairing success

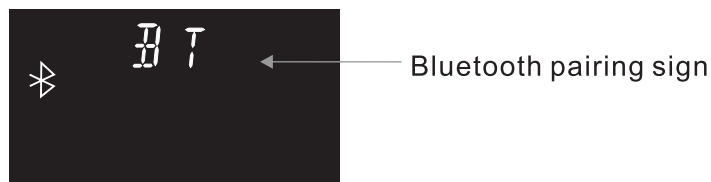

speaker broadcast a piece of music , display show “ 📶 ” sign (pairing finish) as follow:





at bluetooth mode play mobile phone's music:

play/pause: press (▶||
MEM) to play or pause,
track selection: press (**SET**) → (▲) upward track
or (▼) downward track.

Note: you can operating at control panel If mobile phone music player support phone bluetooth ,it don't need to open player interface.

(10)answer the phone call function:when a call come in,speaker ring display show"TEL",then press "  "to answer the call. Press "  " again to hang up after talking.

(11)alarm function:when in emergencies need helps press  the speaker ring to notify help and display shows"ALM" , stop infrared steam and audio function.

3. Power-off: Pressing of () key can switch off all the functions ,drain steam generator water delay 2min and the screen display show "OFF",display off .Main lamp turn off .
Ozone :Ozone function start up when power off and stop auto after 15mins.

5.System wiring diagram:

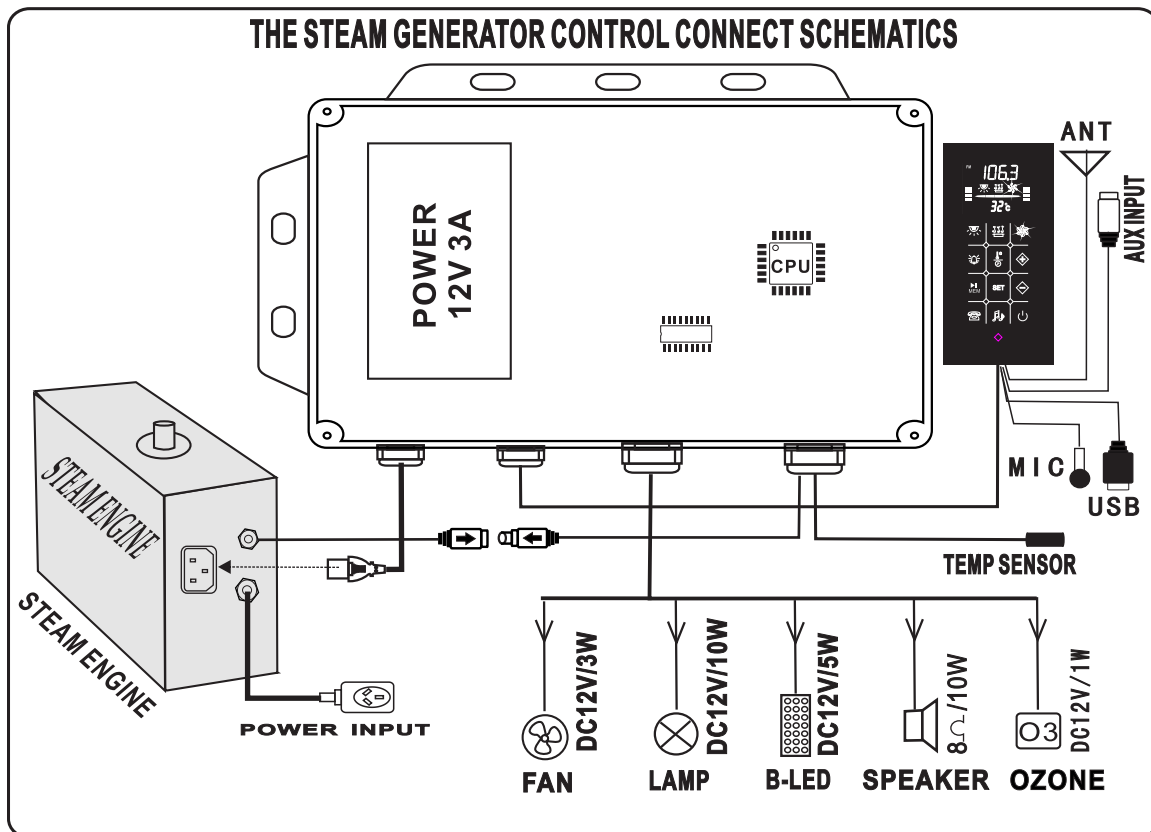

6.THE USE OF REMOTE CONTROL:

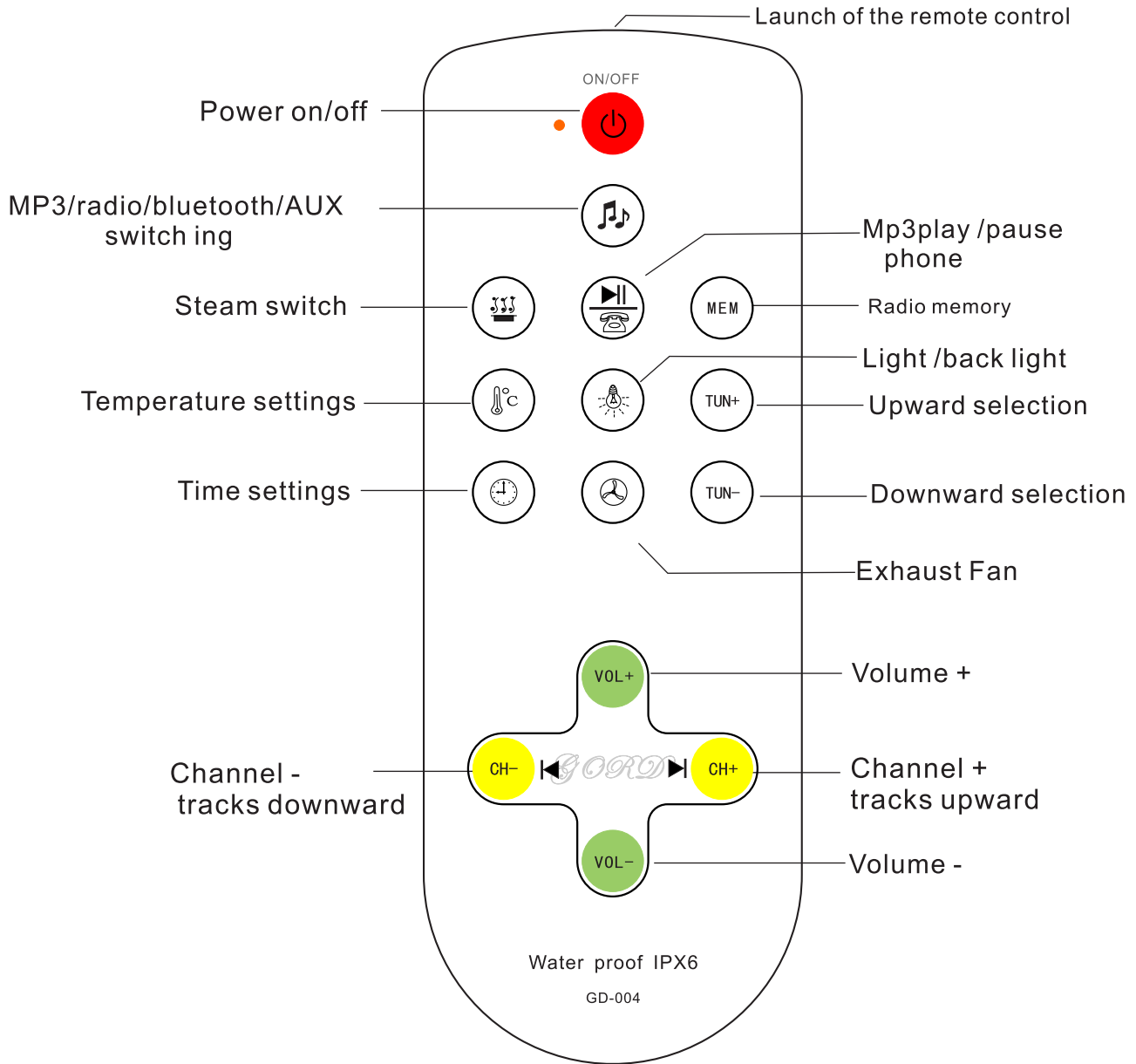

Attention

In order to guarantee the products function, prolong its lifetime and ensure the safety during using, please read the following items carefully before using:

- 1.The end user should carry on the load installation strictly according to the wiring diagram and parameters.
- 2.External audio signal should not be too strong to avoid burning the power amplifier.
- 3.The ground wire of the controller must be in good grounded power lines Controller
- 4.The wire diameter must meet the national standard (GB) 3 x 3mm² , or thicker than that. The supply socket must be over 30mA
- 5.Users must plus an 30A air switch or leakage switch which meet the national standard. The leakage switch of the controller is used for auxiliary repair only
- 6.Please check strictly the wire of power box and control box. After confirming every part is OK, and then you can start the shower device.
- 7.Please do not install the equipments of bad quality that manufactured by illegal factories to the steaming device; Disassembling, changing the fixed inner wiring or connect some wiring to the power box are forbidden.
- 8.The installation of the controller should be carried out by qualified personal according to the installation manual.
- 9.Do not try to repair of the modifier parts of the controller, and the high-voltage might cause danger. All the maintenance and repairing should be carried our by qualified personal.
- 10.For any consequences caused by wrong operation, the user should bear the responsibility.
- 11.This appliance is not intended for use by persons (including children) with reduced physical, sensory or mental capabilities, or lack of experience and knowledge, unless they have been given supervision or

instruction concerning use of the appliance by a person responsible for their safety. Children should be supervised to ensure that they do not play with the appliance.

- 12.If the supply cord is damaged, it must be replaced by the manufacturer, its service agent or similarly qualified persons in order to avoid a hazard.
- 13.To protect against the risk of electrical shock, do not immerse the plug, the cord and the controller in water or other liquid.
- 14.The appliance should be supplied through a residual current device (RCD) having a rated residual operating current not exceeding 30mA.
- 15.Before maintenance and cleaning, please make sure that the power supply must be cut-off.
- 16.WARNING: Only allow children to use the appliance without supervision when adequate instructions have been given so that the child is able to use the appliance in a safe way and understands the hazards of improper use.

- instruction concerning use of the appliance by a person responsible for their safety. Children should be supervised to ensure that they do not play with the appliance.
- 12.If the supply cord is damaged, it must be replaced by the manufacturer, its service agent or similarly qualified persons in order to avoid a hazard.
 - 13.To protect against the risk of electrical shock, do not immerse the plug, the cord and the controller in water or other liquid.
 - 14.The appliance should be supplied through a residual current device (RCD) having a rated residual operating current not exceeding 30mA.
 - 15.Before maintenance and cleaning, please make sure that the power supply must be cut-off.
 - 16.WARNING: Only allow children to use the appliance without supervision when adequate instructions have been given so that the child is able to use the appliance in a safe way and understands the hazards of improper use.

Declaration

1. Any maintenance or repairing should be handled by qualified maintenance personal authorized by the manufacturer or agent of this controller. Otherwise, the products cannot enjoy free maintenance and any results will be borne by the customer.
2. This manual is just for reference. If there are any changes or modifications on the design or explanation, please excuse for no further notice. If there are any mistakes or unclear points, the explaining right belongs to the manufacturer.

